

SERIAL NUMBER: Q/KR. C09-05-186

JIANGMEN KREALUX ELECTRICAL APPLIANCES CO., LTD				MODEL NO: P02-M3			
DRAWN		DATE		EDITION	A	SCALE	2:1

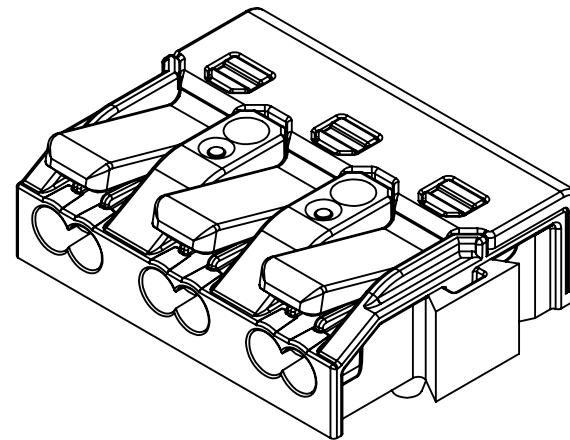
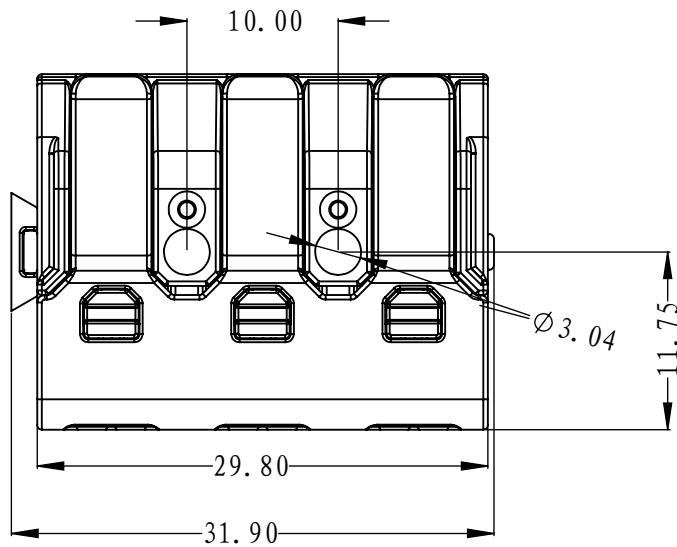
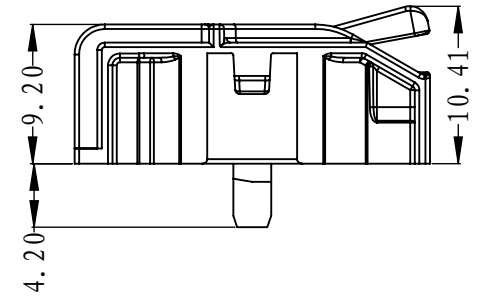
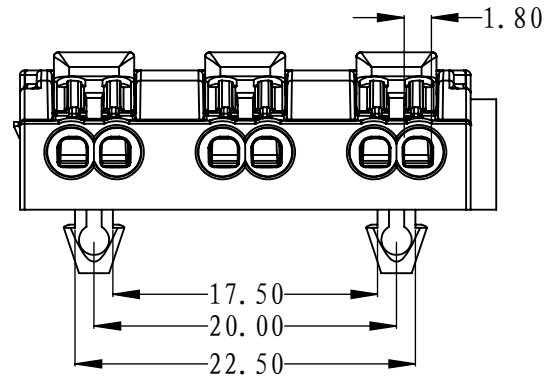
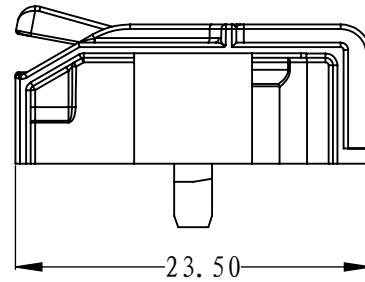
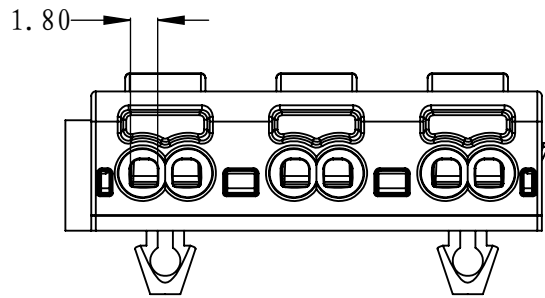
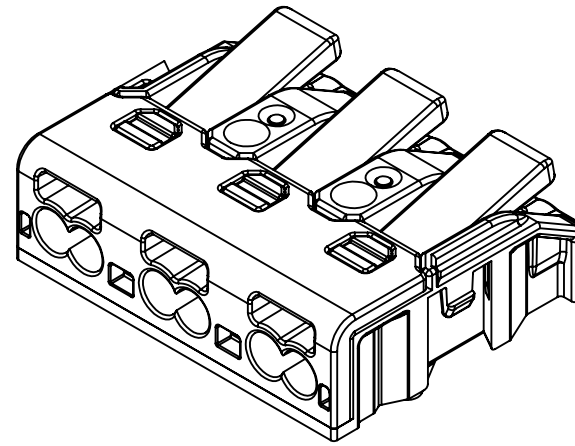
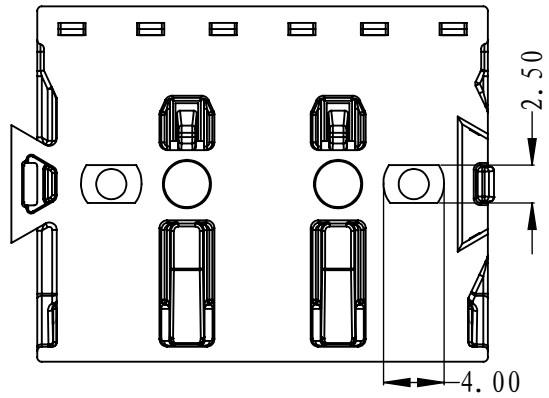

SERIAL NUMBER: Q/KR.C09-05-186

JIANGMEN KREALUX ELECTRICAL APPLIANCES CO., LTD			MODEL NO: P02-M3J		
DRAWN	DATE	EDITION	A	SCALE	2:1